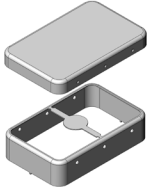
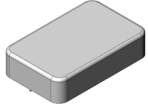

# MS415-20\*

## DRAWN EMI/RFI SHIELD DATA-SHEET

### \*OPTIONAL SHIELD CONFIGURATIONS

MS SHIELD	MS SET PN.	MS ITEM PN.	DESCRIPTION	RAW MATERIAL
	MS415-20	MS415-20C	TWO-PIECE SHIELD COVER	TIN STEEL*
		MS415-20F	TWO-PIECE SHIELD FRAME	
	MS415-20-NS	MS415-20C-NS	TWO-PIECE SHIELD COVER	NICKEL SILVER**
		MS415-20F-NS	TWO-PIECE SHIELD FRAME	
		MS415-20S	ONE-PIECE SHIELD	TIN STEEL*
		MS415-20S-NS	ONE-PIECE SHIELD	NICKEL SILVER**

\* TIN-PLATED STEEL: CRS ELECTROLYTIC TINPLATE

\*\* NICKEL SILVER: UNS C77000 / UNS C73500



MS PN:

DESCRIPTION:

MATERIAL:

© MASACH TECH LTD.  
22 HAGANAN, MODIIN 7169513 ISRAEL  
T: (+972) 8-9754681 / F: (+972) 8-9754682  
info@masach.com / www.masach.com

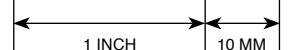

SHIELD TYPE:

**SEAMLESS PROTECTIVE EMI/RFI CAGE**



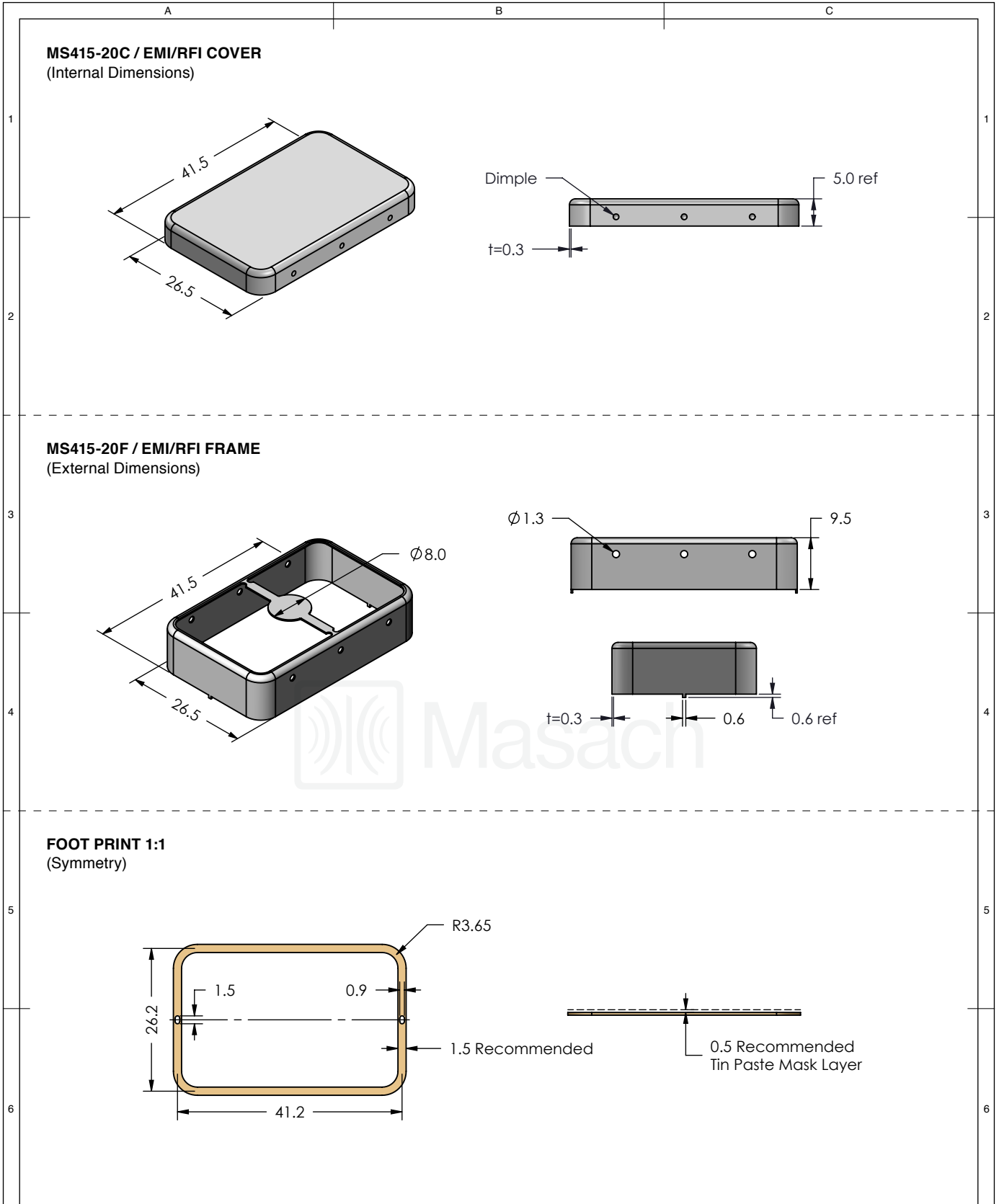

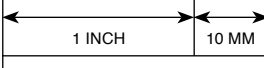

MMGS / PRINT 1:1 / A4

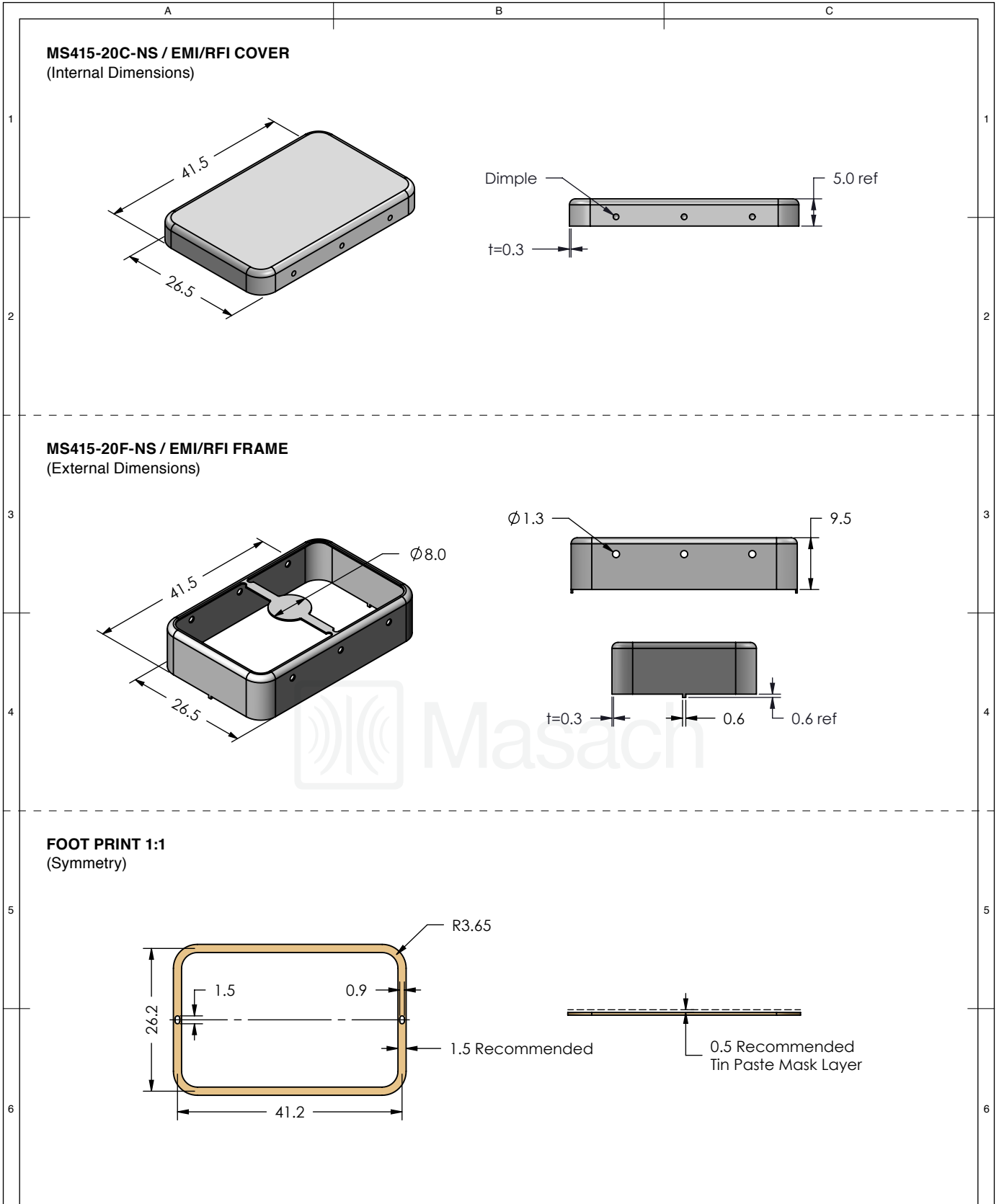

	MS SET PN:	DESCRIPTION:	MATERIAL:
	<b>MS415-20</b>	<b>TWO-PIECE EM/RF SHIELD</b>	<b>TIN PLATED STEEL (1)</b>
<b>NOTE:</b> (1) CRS ELECTROLYTIC TINPLATE (2) GENERAL TOLERANCE (+/-) 0.2MM			
© MASACH TECH LTD. 22 HAGANAN, MODIIN 7169513 ISRAEL T: (+972) 8-9754681 / F: (+972) 8-9754682 <a href="mailto:info@masach.com">info@masach.com</a> / <a href="http://www.masach.com">www.masach.com</a>	SHIELD TYPE:	 	
	<b>SEAMLESS PROTECTIVE EMI/RFI CAGE</b>		MMGS / PRINT 1:1 / A4



This product has been designed and manufactured by © Masach Tech Ltd. The use of this product in any type of electronic device or application is not under Masach Tech Ltd. liability.

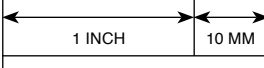

	MS SET PN:	DESCRIPTION:	MATERIAL:
	<b>MS415-20-NS</b>	<b>TWO-PIECE EM/RF SHIELD</b>	<b>NICKEL SILVER (1)</b>
<b>NOTE:</b> (1) UNS C77000 / UNS C73500 (2) GENERAL TOLERANCE (+/-) 0.2MM			
© MASACH TECH LTD. 22 HAGANAN, MODIIN 7169513 ISRAEL T: (+972) 8-9754681 / F: (+972) 8-9754682 <a href="mailto:info@masach.com">info@masach.com</a> / <a href="http://www.masach.com">www.masach.com</a>	SHIELD TYPE:	 	
	<b>SEAMLESS PROTECTIVE EMI/RFI CAGE</b>		MMGS / PRINT 1:1 / A4

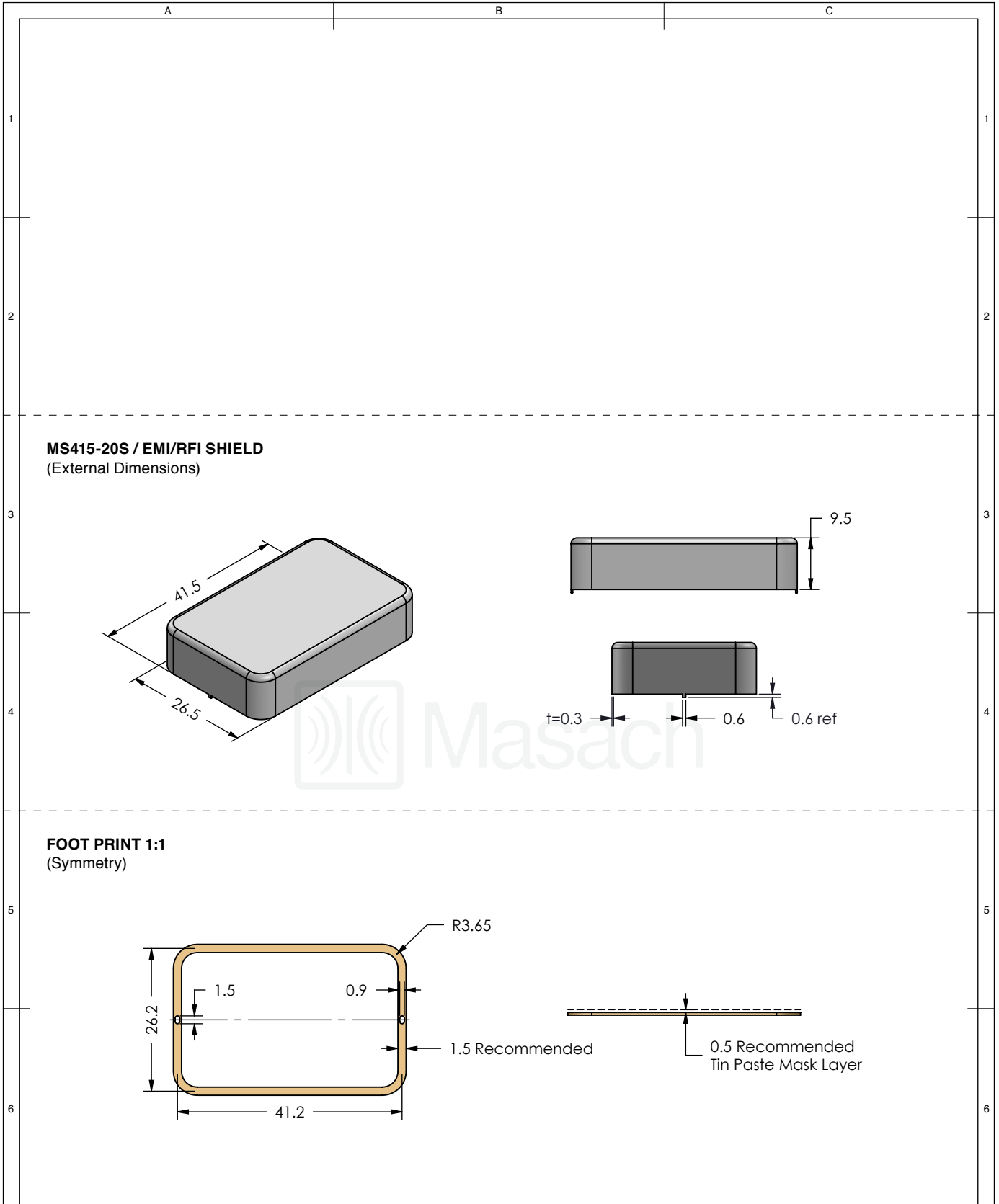

This product has been designed and manufactured by © Masach Tech Ltd. The use of this product in any type of electronic device or application is not under Masach Tech Ltd. liability.

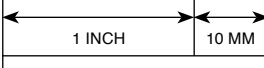

	MS ITEM PN:	DESCRIPTION:	MATERIAL:
	<b>MS415-20S</b>	<b>ONE-PIECE EMI/RF SHIELD</b>	<b>TIN PLATED STEEL (1)</b>
<b>NOTE:</b> (1) CRS ELECTROLYTIC TINPLATE (2) GENERAL TOLERANCE (+/-) 0.2MM			
© MASACH TECH LTD. 22 HAGANAN, MODIIN 7169513 ISRAEL T: (+972) 8-9754681 / F: (+972) 8-9754682 <a href="mailto:info@masach.com">info@masach.com</a> / <a href="http://www.masach.com">www.masach.com</a>	SHIELD TYPE:	 	
	<b>SEAMLESS PROTECTIVE EMI/RFI CAGE</b>		MMGS / PRINT 1:1 / A4

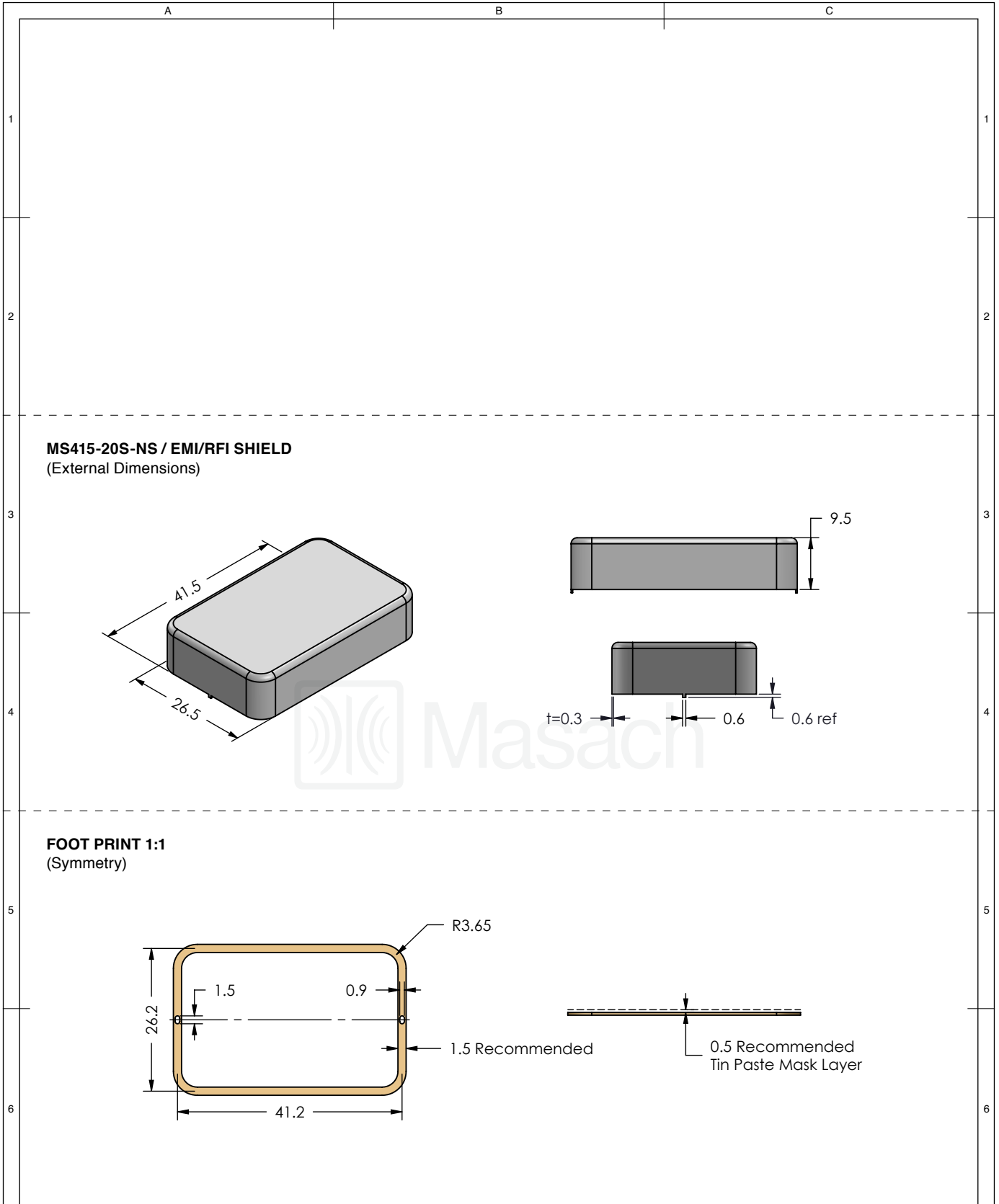
This product has been designed and manufactured by © Masach Tech Ltd. The use of this product in any type of electronic device or application is not under Masach Tech Ltd. liability.

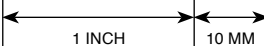

	MS ITEM PN:	DESCRIPTION:	MATERIAL:
	<b>MS415-20S-NS</b>	<b>ONE-PIECE EMI/RF SHIELD</b>	<b>NICKEL SILVER (1)</b>
<b>NOTE:</b> (1) UNS C77000 / UNS C73500 (2) GENERAL TOLERANCE (+/-) 0.2MM			
© MASACH TECH LTD. 22 HAGANAN, MODIIN 7169513 ISRAEL T: (+972) 8-9754681 / F: (+972) 8-9754682 <a href="mailto:info@masach.com">info@masach.com</a> / <a href="http://www.masach.com">www.masach.com</a>	SHIELD TYPE:	 	
	<b>SEAMLESS PROTECTIVE EMI/RFI CAGE</b>		MMGS / PRINT 1:1 / A4

This product has been designed and manufactured by © Masach Tech Ltd. The use of this product in any type of electronic device or application is not under Masach Tech Ltd. liability.

A

B

C

### MS415-20\* / SMALL PACKING TRAY / SMD

\* COMPATIBLE TO ALL SHIELD CONFIGURATIONS

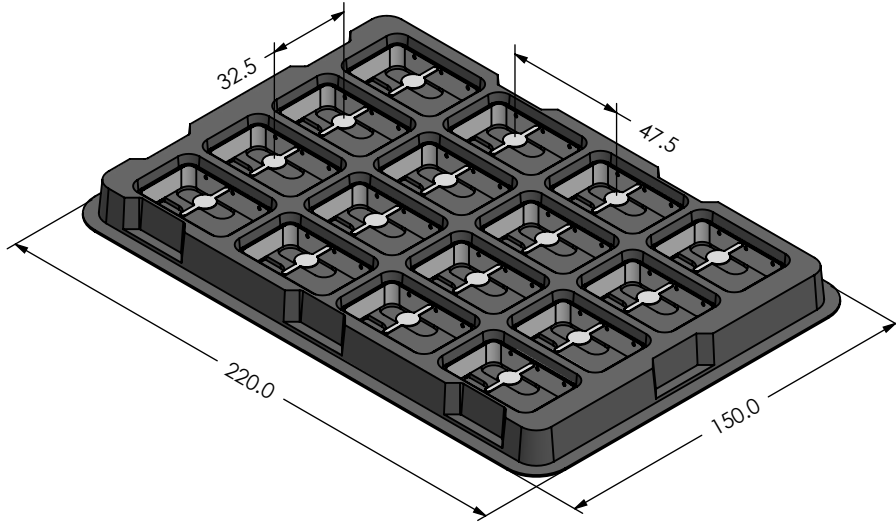

### MS415-20\* / LARGE PACKING TRAY / SMD

\* COMPATIBLE TO ALL SHIELD CONFIGURATIONS

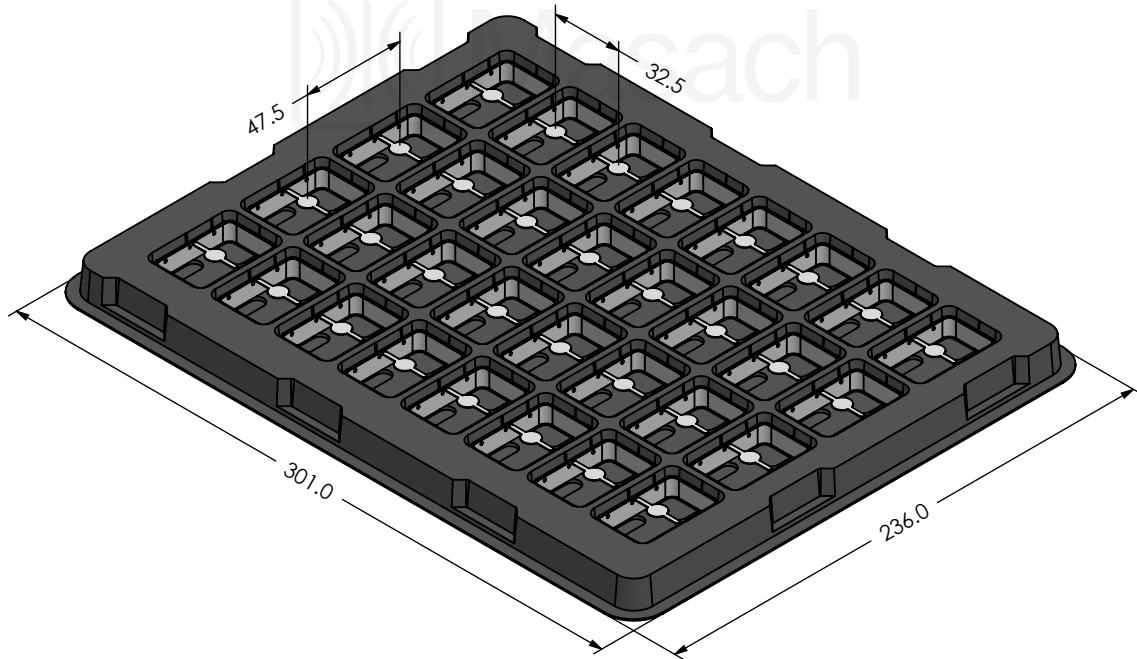

MS PN:

DESCRIPTION:

MATERIAL:

© MASACH TECH LTD.  
 22 HAGANAN, MODIIN 7169513 ISRAEL  
 T: (+972) 8-9754681 / F: (+972) 8-9754682  
 info@masach.com / www.masach.com

SHIELD TYPE:

**SEAMLESS PROTECTIVE EMI/RFI CAGE**

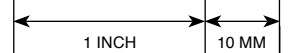

MMGS / PRINT 1:1 / A4

This product has been designed and manufactured by © Masach Tech Ltd. The use of this product in any type of electronic device or application is not under Masach Tech Ltd. liability.

[BACK TO TOP](#)