

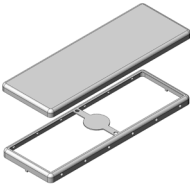

MS593-10*

DRAWN EMI/RFI SHIELD DATA-SHEET

*OPTIONAL SHIELD CONFIGURATIONS

MS SHIELD	MS SET PN.	MS ITEM PN.	DESCRIPTION	RAW MATERIAL
	MS593-10	MS593-10C	TWO-PIECE SHIELD COVER	TIN STEEL*
		MS593-10F	TWO-PIECE SHIELD FRAME	
	MS593-10-NS	MS593-10C-NS	TWO-PIECE SHIELD COVER	NICKEL SILVER**
		MS593-10F-NS	TWO-PIECE SHIELD FRAME	
		MS593-10S	ONE-PIECE SHIELD	TIN STEEL*
		MS593-10S-NS	ONE-PIECE SHIELD	NICKEL SILVER**

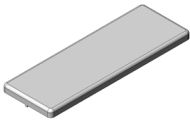
* TIN-PLATED STEEL: CRS ELECTROLYTIC TINPLATE

** NICKEL SILVER: UNS C77000 / UNS C73500



MS PN:

DESCRIPTION:

MATERIAL:

© MASACH TECH LTD.
22 HAGANAN, MODIIN 7169513 ISRAEL
T: (+972) 8-9754681 / F: (+972) 8-9754682
info@masach.com / www.masach.com



SHIELD TYPE:

SEAMLESS PROTECTIVE EMI/RFI CAGE



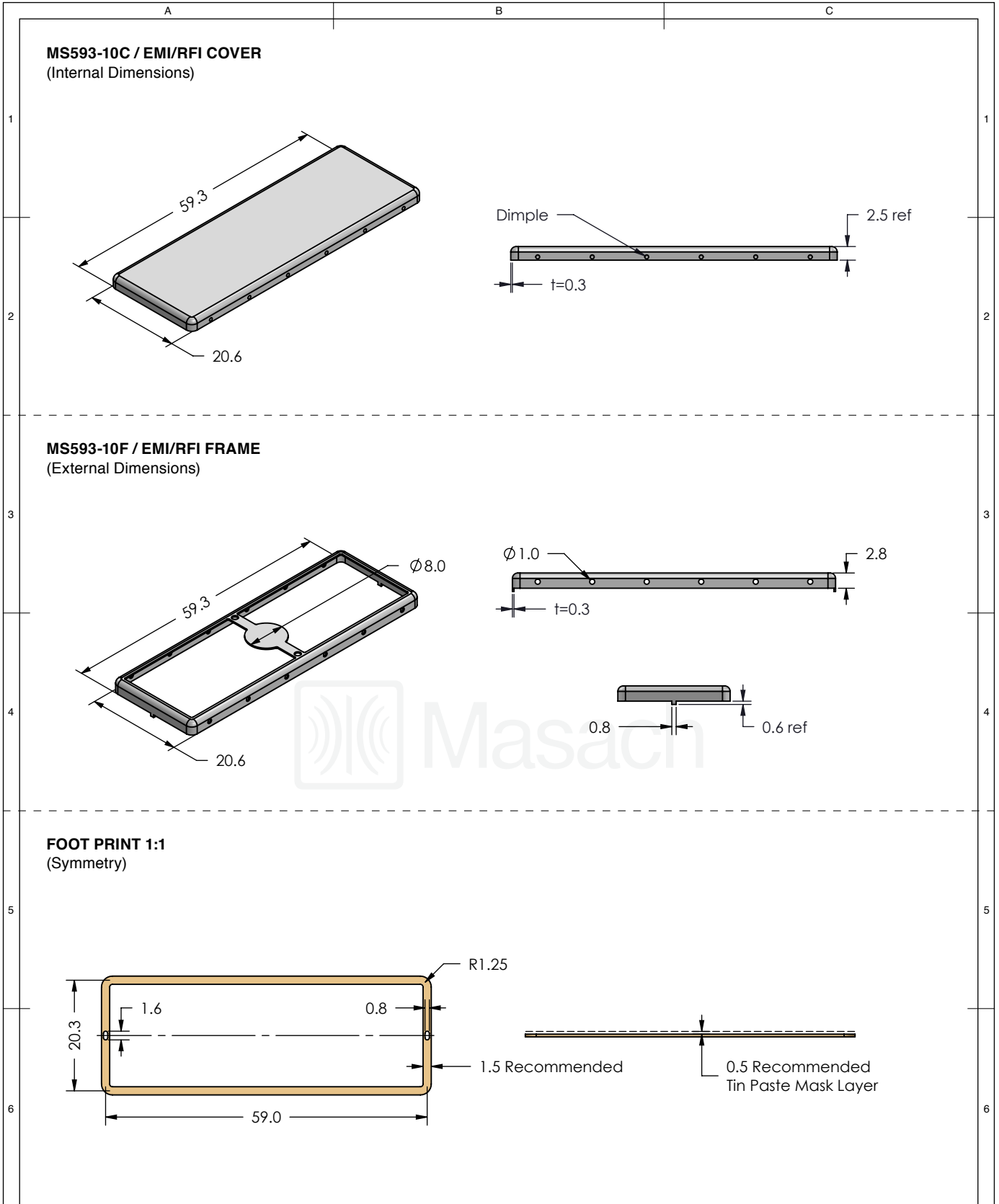

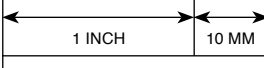

MMGS / PRINT 1:1 / A4

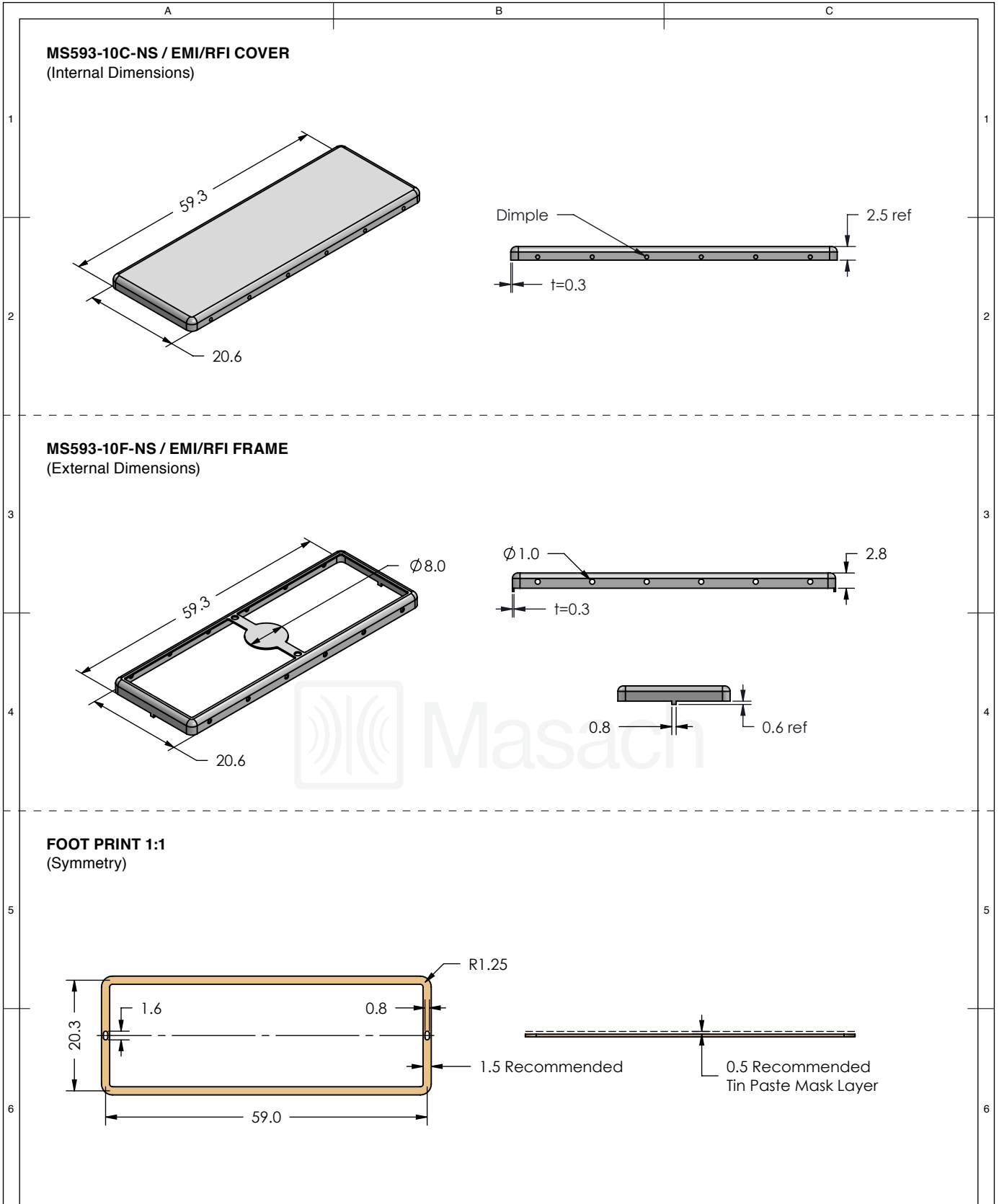

	MS SET PN:	DESCRIPTION:	MATERIAL:
	MS593-10	TWO-PIECE EM/RF SHIELD	TIN PLATED STEEL (1)
NOTE: (1) CRS ELECTROLYTIC TINPLATE (2) GENERAL TOLERANCE (+/-) 0.2MM			
© MASACH TECH LTD. 22 HAGANAN, MODIIN 7169513 ISRAEL T: (+972) 8-9754681 / F: (+972) 8-9754682 info@masach.com / www.masach.com	SHIELD TYPE:	 	
	SEAMLESS PROTECTIVE EMI/RFI CAGE		MMGS / PRINT 1:1 / A4

This product has been designed and manufactured by © Masach Tech Ltd. The use of this product in any type of electronic device or application is not under Masach Tech Ltd. liability.



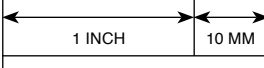

	MS SET PN:	DESCRIPTION:	MATERIAL:
	MS593-10-NS	TWO-PIECE EM/RF SHIELD	NICKEL SILVER (1)
NOTE: (1) UNS C77000 / UNS C73500 (2) GENERAL TOLERANCE (+/-) 0.2MM			
© MASACH TECH LTD. 22 HAGANAN, MODIIN 7169513 ISRAEL T: (+972) 8-9754681 / F: (+972) 8-9754682 info@masach.com / www.masach.com	SHIELD TYPE:	 	
	SEAMLESS PROTECTIVE EMI/RFI CAGE		MMGS / PRINT 1:1 / A4

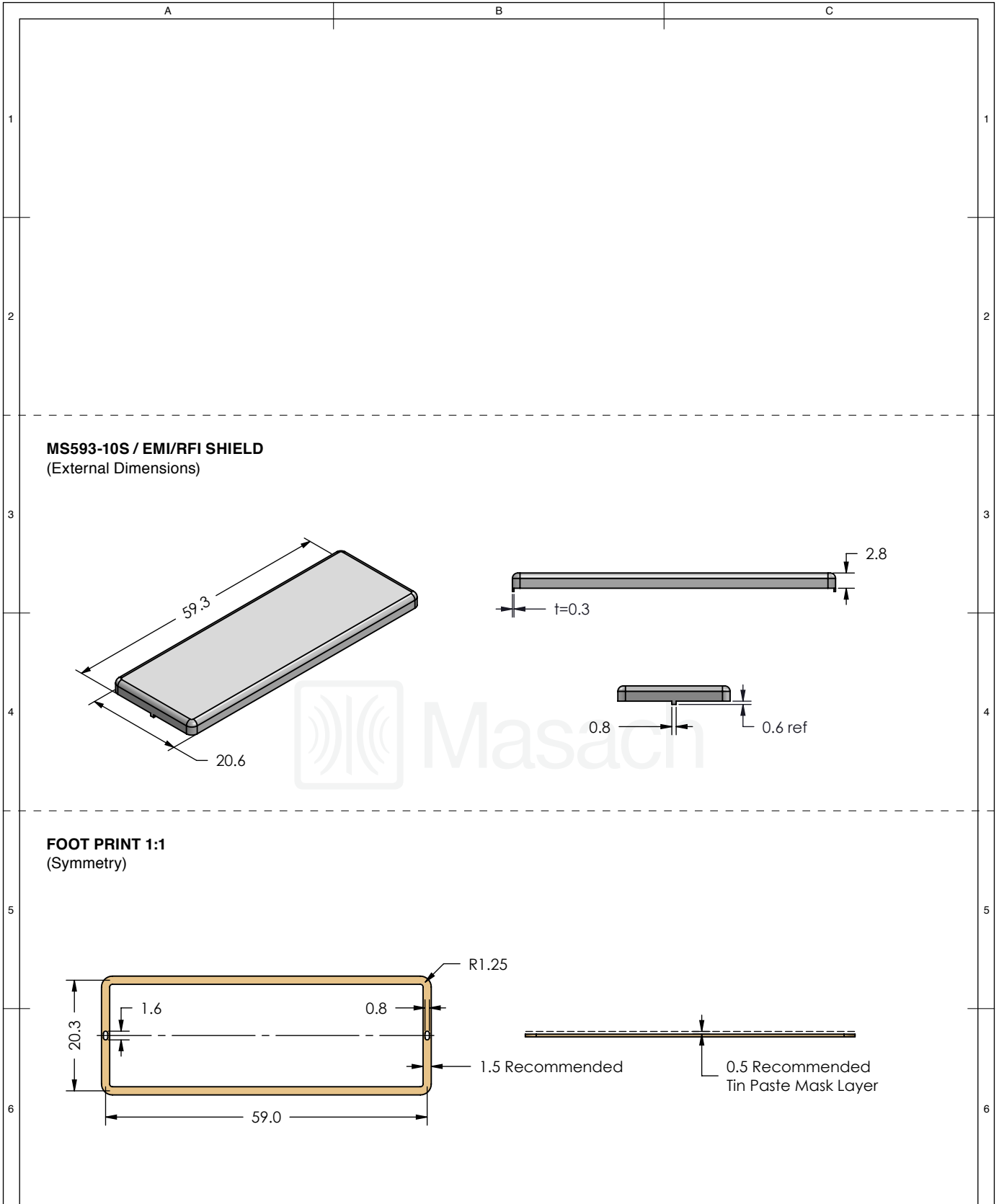
This product has been designed and manufactured by © Masach Tech Ltd. The use of this product in any type of electronic device or application is not under Masach Tech Ltd. liability.



MS593-10S / EMI/RFI SHIELD
(External Dimensions)

FOOT PRINT 1:1
(Symmetry)

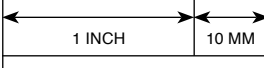
	MS ITEM PN:	DESCRIPTION:	MATERIAL:
	MS593-10S	ONE-PIECE EMI/RF SHIELD	TIN PLATED STEEL (1)
<p>NOTE: (1) CRS ELECTROLYTIC TINPLATE (2) GENERAL TOLERANCE (+/-) 0.2MM</p>			
<p>© MASACH TECH LTD. 22 HAGANAN, MODIIN 7169513 ISRAEL T: (+972) 8-9754681 / F: (+972) 8-9754682 info@masach.com / www.masach.com</p>	SHIELD TYPE:	 	
	SEAMLESS PROTECTIVE EMI/RFI CAGE		MMGS / PRINT 1:1 / A4

This product has been designed and manufactured by © Masach Tech Ltd. The use of this product in any type of electronic device or application is not under Masach Tech Ltd. liability.

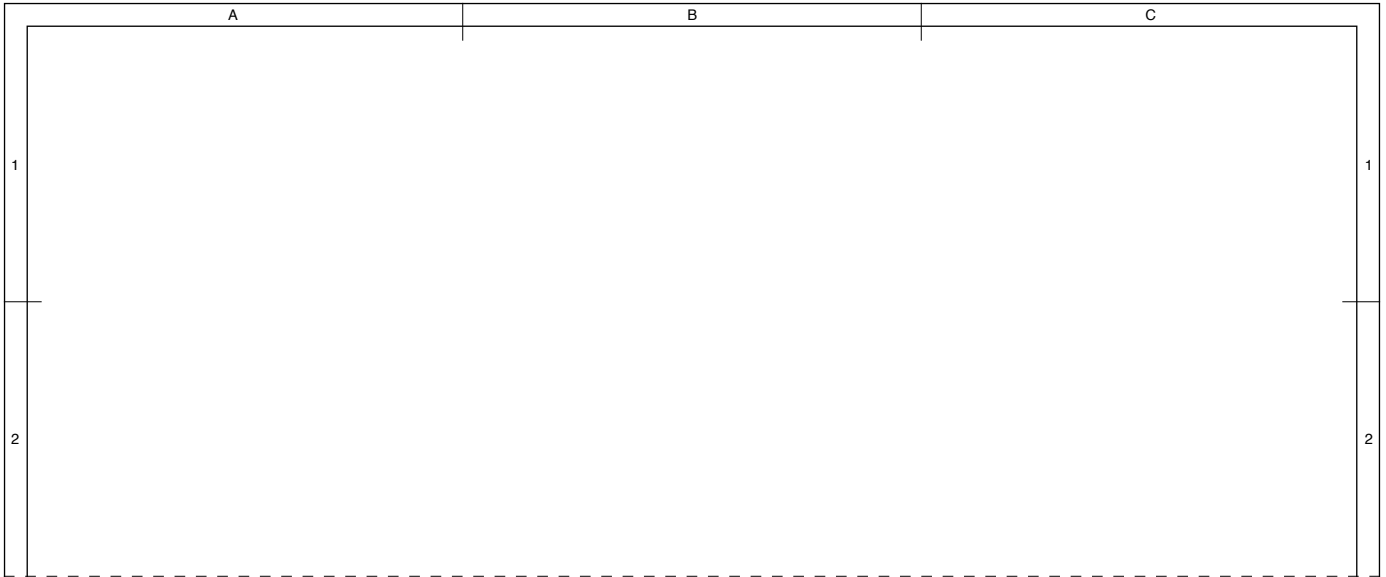

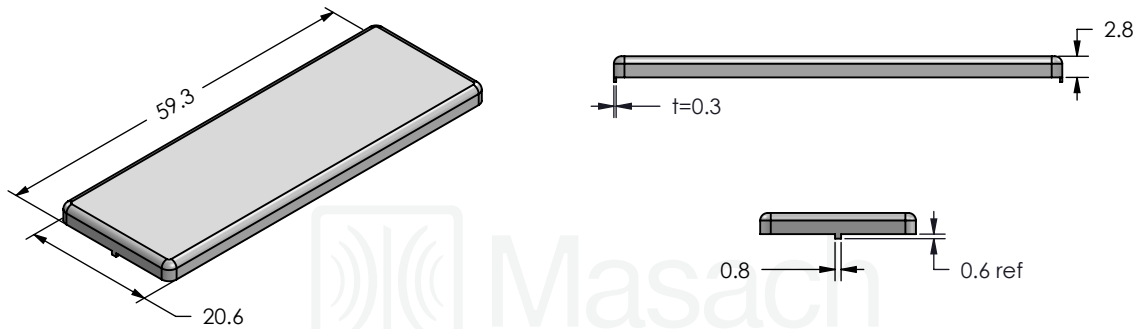

MS593-10S-NS / EMI/RFI SHIELD
(External Dimensions)

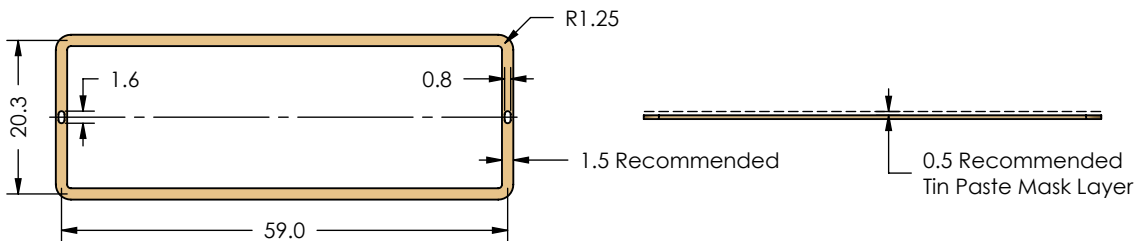

FOOT PRINT 1:1
(Symmetry)

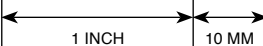

	MS ITEM PN:	DESCRIPTION:	MATERIAL:
	MS593-10S-NS	ONE-PIECE EMI/RF SHIELD	NICKEL SILVER (1)
NOTE: (1) UNS C77000 / UNS C73500 (2) GENERAL TOLERANCE (+/-) 0.2MM			
© MASACH TECH LTD. 22 HAGANAN, MODIIN 7169513 ISRAEL T: (+972) 8-9754681 / F: (+972) 8-9754682 info@masach.com / www.masach.com	SHIELD TYPE:	 	
	SEAMLESS PROTECTIVE EMI/RFI CAGE		MMGS / PRINT 1:1 / A4

This product has been designed and manufactured by © Masach Tech Ltd. The use of this product in any type of electronic device or application is not under Masach Tech Ltd. liability.

A

B

C

MS593-10* / SMALL PACKING TRAY / SMD

* COMPATIBLE TO ALL SHIELD CONFIGURATIONS

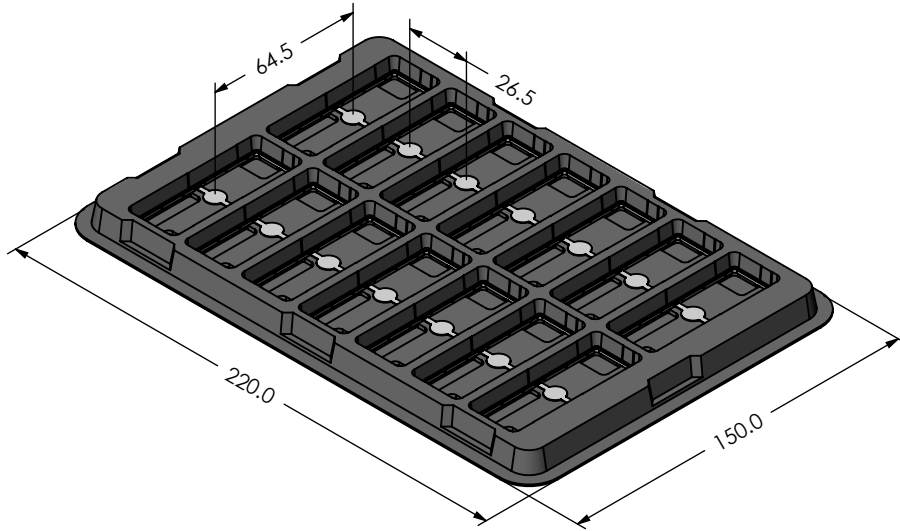

MS593-10* / LARGE PACKING TRAY / SMD

* COMPATIBLE TO ALL SHIELD CONFIGURATIONS

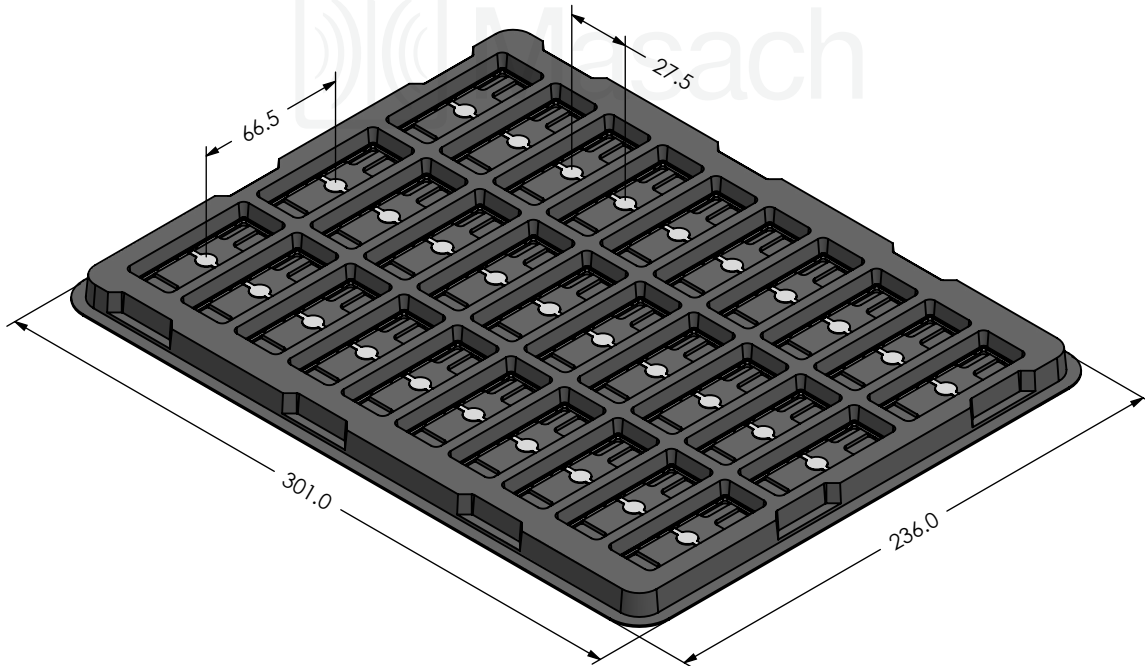

MS PN:

DESCRIPTION:

MATERIAL:

© MASACH TECH LTD.
 22 HAGANAN, MODIIN 7169513 ISRAEL
 T: (+972) 8-9754681 / F: (+972) 8-9754682
 info@masach.com / www.masach.com

SHIELD TYPE:

SEAMLESS PROTECTIVE EMI/RFI CAGE

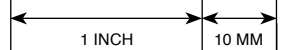

MMGS / PRINT 1:1 / A4

This product has been designed and manufactured by © Masach Tech Ltd. The use of this product in any type of electronic device or application is not under Masach Tech Ltd. liability.

[BACK TO TOP](#)