

	Item No:	Description:	Material:
	MS353-10	DRAWN EMI/RFI SHEILD Frame + Cover	TIN PLATED STEEL (See Note 1-2)
<p>NOTE. (1) TS275E 8.4/8.4 (2) ELECTROYTIC TIN PLATE AS PER EN 10202:2001 MIN TIN THICKNESS 3.5 UM (3) GENERAL TOLERANE (+/-) 0.2MM NON DIMENSIONED ITEMS REMAIN MASACH TECHNOLOGIES LTD. PROPERTY.</p>			
MASACH TECHNOLOGIES LTD. 22 HAGANAN ST. MODIIN 7171801 ISRAEL T: (+972) 8 9754681 / F: (+972) 8 9754682 info@masach.com / www.masach.com	SEAMLESS PROTECTIVE CAGE		
			MMGS / PRINT 1:1 / A4

MS353-10 / SMT PACKING TRAY*

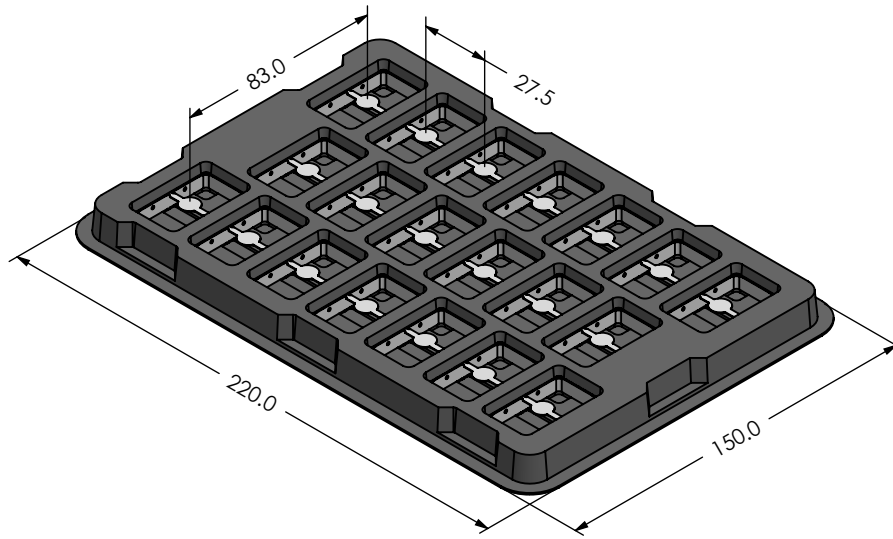

* Other packing options are available upon request



TINPLATE STEEL STOCK / STORAGE & HANDLING

Materials Specification: Cold Reduced Electrolytic Tinplate Steel
Tinplate Standard: TS275E8.4/8.4 EN 10202:2001

The materials used to fabricate these shields are based on a mild steel with less than 0.12% Carbon and no more than 1% alloying elements and naturally occurring impurities. Major shielding elements are thus ferrous and tin. The thin resultant layer of tin enables shields to be soldered easily to pc boards as well as providing a corrosion resistant protection during the assembly process. Tin plate shields are the most cost effective materials in the shielding screen family provided the following care is taken during storage and handling.

1. Do not pass these components through a salt bath test, they are not designed for such severe treatment, alternate materials (albeit more expensive) are available.
2. Frames should be left in package trays until assembly, the trays preserve the planarity of the shields.
3. Store in a cool dry place and avoid water or other liquids from coming into contact with shields.
4. Mild scratching and scuffs are natural for processed shields from pre-plated material. Protective films can be ordered specially for unblemished finish of covers.
5. Extremely thin film of oil may cover some shields, this does not have any effect on solder ability and does not have to be removed.

Tinplate shields constitute over 85% of the materials used in the Masach production programme and have proven effective in their respective applications.

	Item No:	Description:	Material:
	MS353-10	DRAWN EMI/RFI SHEILD Frame + Cover	TIN PLATED STEEL (See Note 1-2)
<p>NOTE. (1) TS275E 8.4/8.4 (2) ELECTROYTIC TIN PLATE AS PER EN 10202:2001 MIN TIN THICKNESS 3.5 UM (3) GENERAL TOLERANE (+/-) 0.2MM NON DIMENSIONED ITEMS REMAIN MASACH TECHNOLOGIES LTD. PROPERTY.</p>			
MASACH TECHNOLOGIES LTD. 22 HAGANAN ST. MODIIN 7171801 ISRAEL T: (+972) 8 9754681 / F: (+972) 8 9754682 info@masach.com / www.masach.com	SEAMLESS PROTECTIVE CAGE		
			PRINT 1:1 / A4